

## ATS-2

### Audio Test and Measurement System

Unmatched Value

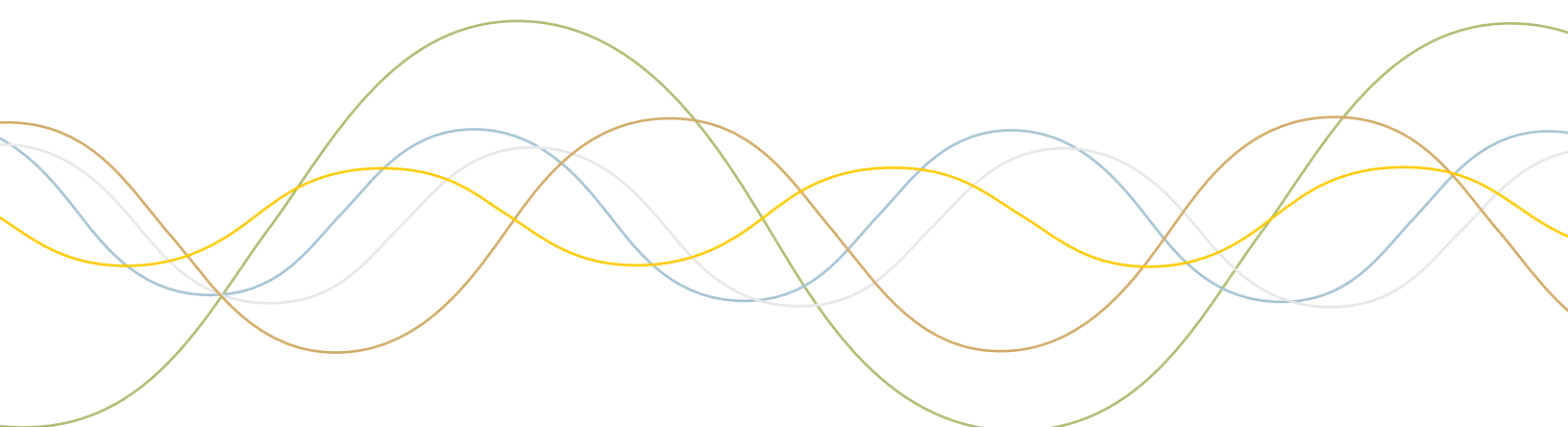

## Turn on ATS-2: Audio Testing to Meet Your Deadline and Budget

Multitone test signal from Generator with flat spectrum and virtually no distortion and noise. Note some frequencies in the higher area of the spectrum are different on each channel to allow for crosstalk measurements.

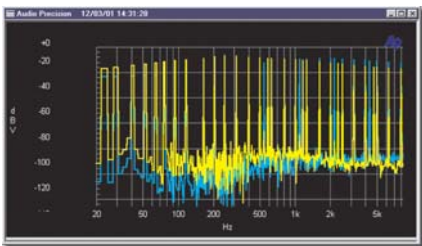
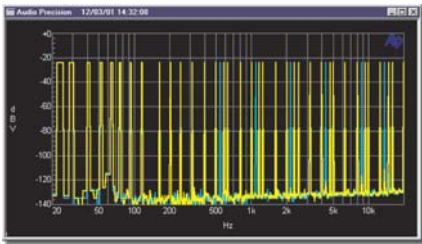

Multitone signal received from the device under test. Note the amplitude of the fundamentals is representing the response of the device and the higher signals near the bottom of the spectrum represent noise and distortion.

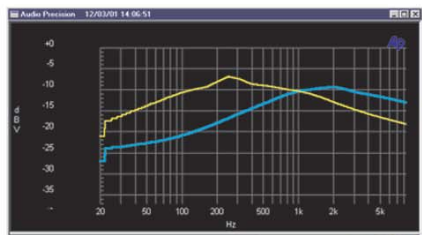

Frequency Response

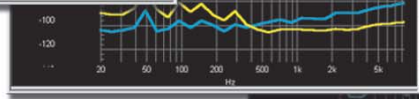

Noise vs. Frequency

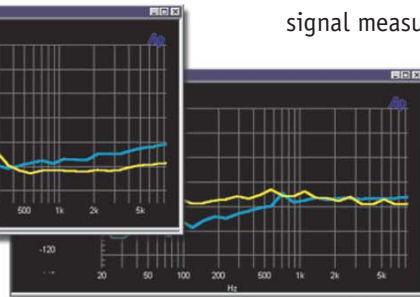

Distortion vs. Frequency

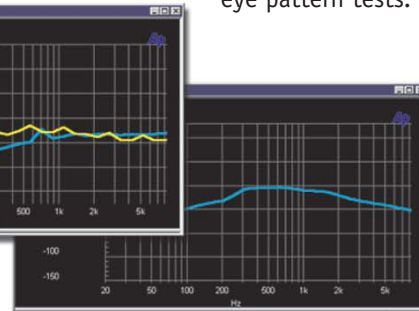

Interchannel Phase Response

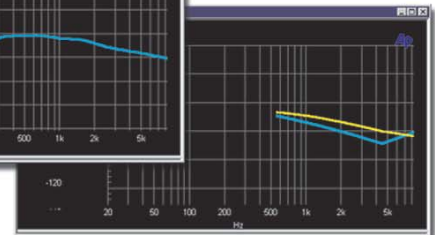

Interchannel Crosstalk

Audio Precision's PC-controlled ATS-2 audio test and measurement system provides design engineers and technicians with Audio Precision quality and the ability to choose performance capabilities to match specific needs and budgets. By quickly discovering and isolating circuit problems with its Harmonic Distortion Analyzer, ATS-2 can dramatically decrease your time to market. With its Multitone Analyzer, ATS-2 provides comprehensive solutions to your audio testing challenges by executing five performance tests in a single acquisition, collating all the data you need to graph any test result—all in less than one second. And because it's PC-controlled, ATS-2 allows you to leverage your existing PC investment.

### Multitone Performance Tests

- 2-Channel Frequency Response
- Noise versus Frequency
- Total Distortion versus Frequency
- Interchannel Separation versus Frequency
- Interchannel Phase Response

The interface measurement capability in ATS-2 determines whether or not the signal from a digital device meets standards and is compatible with other devices. High performance measurement capabilities include jitter and FFT of jitter, pulse amplitude, word width, bit activity, sample rate and high-level decoded status bits. Interface stimulus features simulate real-world degradations to measure the effect on the device during testing.

Audio Precision also offers a performance option for the ATS-2 that increases the analyzer bandwidth to 120 kHz and includes complete digital interface signal measurement and analysis, including waveform display and eye pattern tests.

## High Performance, Simplified

ATS-2 offers dual analyzers to quickly identify and repair the problems that occur during the design and manufacture of audio equipment. The Harmonic Distortion Analyzer provides insight into a variety of circuit malfunctions, allowing an engineer or technician to isolate circuit problems and fix them quickly. The Multitone Analyzer—an FFT analyzer coupled with an arbitrary waveform generator—performs a variety of performance tests quickly. Without multitone, those tests must be set up and executed one at a time.

With PC-controlled functionality, ATS-2 allows you to leverage your existing PC investment and gives you a familiar interface to:

- Monitor instruments
- Graphically display test data
- Manage files for test setups
- Easily share and archive data
- Generate reports with your preferred word processing application; and
- Export test data to analysis programs—such as MATLAB®—for extended analysis.

The PC-controlled ATS-2 lets you enjoy the longevity of Audio Precision test and measurement equipment without sacrificing the regular performance upgrades available with your PC platform.

## Reach Your Market Faster

The rapid, single acquisition testing of ATS-2's Multitone Analyzer saves you the time and expense of individually setting up and executing each test. It eliminates errors by providing a comprehensive set of answers to your performance questions with one easy setup. By decreasing the time spent on finding and fixing circuit problems, ATS-2 decreases your time to market.

## High Performance, Unmatched Value

The ATS-2 provides design engineers and technicians with Audio Precision quality and the ability to choose performance capabilities to match specific needs and budgets. By getting you to market faster through a dramatically faster testing process, ATS-2 allows for a quicker return on investment on your developments. And by leveraging your existing PCs, ATS-2 increases your asset utilization, helping to improve your design's financial performance. And the inherent high-reliability of the ATS-2 is backed up by a three-year warranty, the best in the industry.

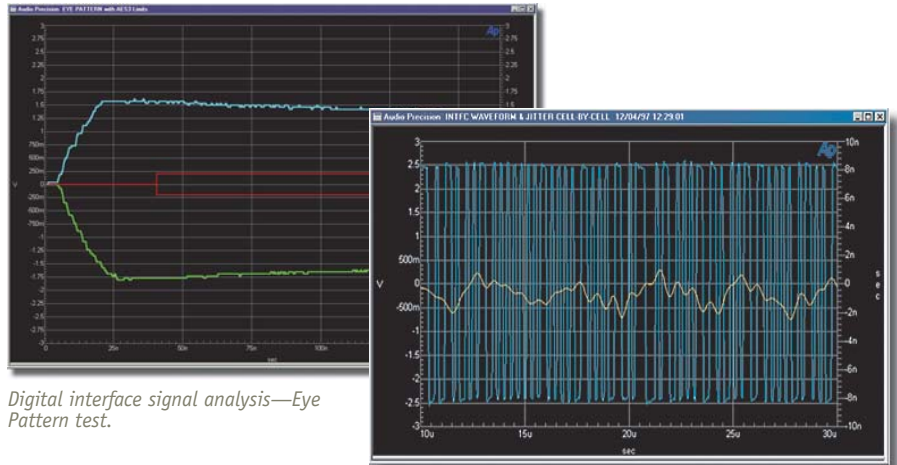

Digital interface signal analysis—Eye Pattern test.

Digital interface signal analysis—Interface Waveform Jitter, cell-by-cell.

## Turn on ATS-2: Audio Testing to Meet Your Challenges

### High Performance, by Design

ATS-2 sets a new mark in value for computer-controlled audio testing systems. ATS-2 puts a broad set of capabilities, high measurement performance and a proud legacy of excellence into a light-weight, compact and affordable general purpose instrument suited to the design lab, broadcast facility or production line.

### Signal Generators

ATS-2 has two independent signal generators, one for analog output and one for digital output. The two generators can each create a large number of test signals, including:

- Sine waves as: mono, stereo, phase-shifted, tone bursts, dual.
- Noise
- Square waves
- Special waveforms, including polarity, a pass-through function and special digital waveforms
- Arbitrary waveforms, including Multitone signals (predefined or user defined using supplied utility).

### Key ATS-2 features

- Analog and digital inputs and outputs.
- Generation of test signals for both analog and digital devices.
- Multi-functioned audio analysis, spectrum analysis, multitone analysis, detailed harmonic analysis, optional interface analysis.
- Full complement of graphing and report options.

### Inputs and Outputs

ATS-2 offers both balanced and unbalanced connections for both analog and digital signal domains. For digital signals, the balanced connections satisfy the electrical and mechanical aspects of AES3 and IEC60958-4, offering dual-connector mode as well. The unbalanced connections satisfy AES3id and are also suitable for S/PDIF signals. Optical connectors are also provided.

Signals in either the analog or digital domain can be characterized for audio performance with the Audio Analyzer that provides a comprehensive set of measurement functions including:

- Amplitude
- Noise (weighted, band limited, or narrow band)
- 2-Channel Amplitude Ratio
- Crosstalk (Channel Separation)
- THD+N (both ratio and absolute amplitude)
- SMPTE/DIN Intermodulation Distortion
- Phase

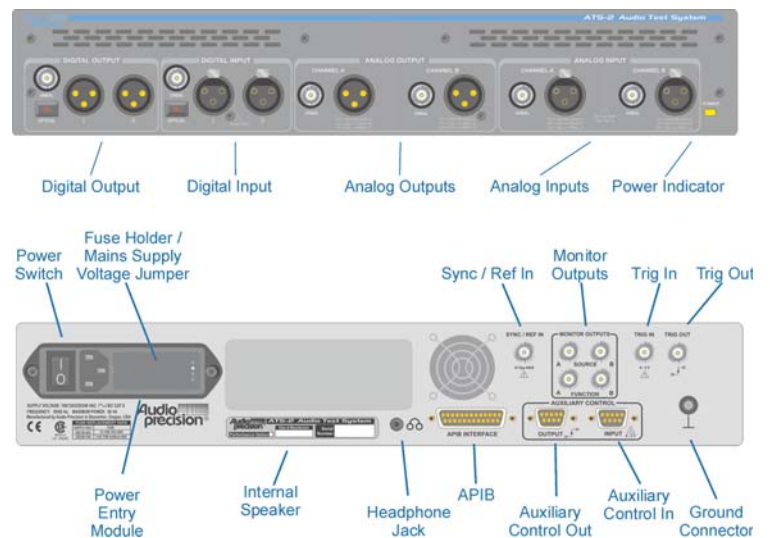
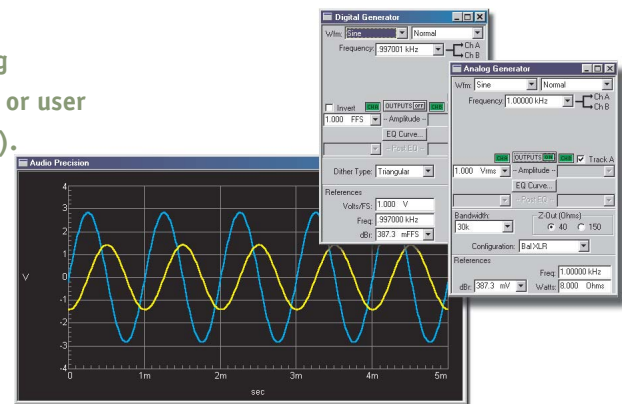

# Comprehensive Measurements

# challenges

A broad range of analysis functions offer a comprehensive suite of measurement capabilities. The Audio Analyzer, Spectrum Analyzer, Multitone Analyzer, Harmonic Analyzer, and Digital Interface Analyzer each offer powerful and unique features.

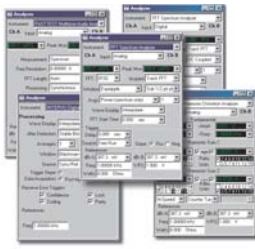

Five separate Analyzers cover all measurements.

detail. It provides information about signal jitter including jitter amplitude, jitter waveform, jitter spectrum. The Eye Pattern display is a concise, easy to interpret measure of digital interface performance. Powerful analytical and statistical analysis is provided with interface amplitude histograms, interface pulse width histograms, interface bit-width histograms, and Jitter histograms.

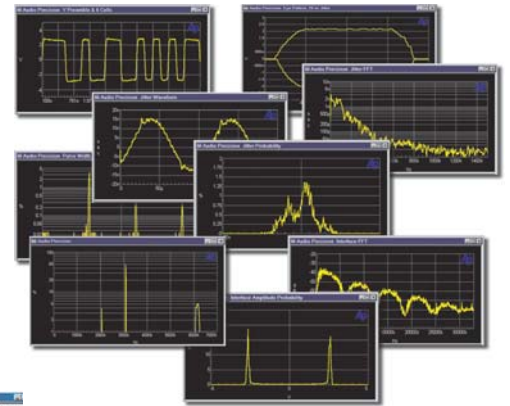

Broad Digital Signal analysis capability shown by the nine graphs depicted here.

## Audio Analyzer

A two-channel analyzer that measures level, frequency, noise, THD+N, crosstalk, phase, and frequency-selective level. The measurement functions offer combinations of detector selections and filtering including band limiting, band pass, weighting, and notch. Detectors may be rms, average, and peak allowing any international standard to be met.

## Spectrum Analyzer

The Spectrum Analyzer is a general-purpose FFT instrument that generates frequency-domain (spectrum) displays, with selectable acquisition times, windowing and averaging functions. Display can be toggled between spectrum (frequency) and oscilloscope (time) views.

## Multitone Analyzer

The Multitone Analyzer uses specially-designed multitone stimulus signals with specialized FFT analysis to rapidly capture a complete suite of audio performance parameters in under a second. (See page 2 for examples)

## Interface Analysis (Performance Option)

The Digital Interface Analyzer is a powerful measurement capability that examines the digital interface signal in

## Harmonic Analyzer

The Harmonic Analyzer provides a detailed look at individual harmonic distortion products. Particularly useful with the sweep facility to generate graphs of individual harmonics versus frequency.

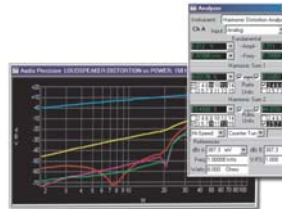

Harmonic Analyzer panel and graph of individual harmonic amplitude versus frequency.

## Sweeps and Graphs

Most ATS-2 settings and readings can be designated as independent or dependent variables and be plotted against one another using the comprehensive ATS-2 sweep and graph functions. Extensive attribute controls allow a wide variation of the visual appearance of the graphs, including color, axis dimensions, and size. Flexible export capability allows integration of graphs in various report programs.

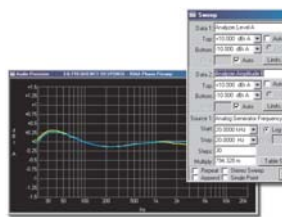

Flexible sweep and graph controls allow up to 6 simultaneous measurements to be graphed at once with extensive selection of variable elements and graph presentation.

## Automation

A powerful Visual Basic®-like scripting language, AP Basic, allows sophisticated multi-step test sequences to be automated. Create self-running test procedures, test for conformance to pre-defined limits, allow

simple user input, and automatically generate anything from a simple Pass/Fail condition with simple trouble ticket up to a multipage graphical report.



Extensive scripting language and a sophisticated editor allow easy creation of automated test

A "learn mode" lets even non-programmers create sophisticated test procedures incorporating OLE commands.



## Extensibility

For measurement situations where more than two channels are required, outboard switchers can expand the number of channels in groups of 12. An external multi-function accessory can add DC volts and ohms measurement, DC voltage sources, and utility input and output control for push buttons and relays.

## Enterprise collaboration

PC-based ATS software allows easy collaboration in a team environment. Email test procedures, test data, and graphs to quickly duplicate test results, study test data, or publish reports regardless of location.

## SIGNAL GENERATOR OUTPUTS

Waveforms	Analog	Digital
	Sine Family (Normal, Var Phase, Stereo, Dual, Shaped Burst, EQ), IMD (SMPTE/DIN 4:1, 1:1) Square, Noise, Arbitrary Waveform (Multitone), Special (Polarity, Pass Thru)	Sine Family (Normal, Var Phase, Stereo, Dual, Shaped Burst, EQ, Burst, Offset) IMD (SMPTE/DIN 4:1, 1:1) Square, Noise, Arbitrary Waveform (Multitone), Special (Polarity, Pass Thru, Monotonicity, J-Test, Walking Ones, Walking Zeros, Constant Value, Random)
<b>Sine Wave</b>	<b>Analog</b>	<b>Digital</b>
Frequency Range	2 Hz to 61.6 kHz	2 Hz to .50 x SR (Sample Rate)
Frequency Accuracy	±0.0002%	
Frequency Resolution		SR/2 <sup>23</sup>
Amplitude Range		
Balanced	<250 $\mu$ Vrms to 16.00 Vrms [+26.3 dBu]	
Unbalanced	<250 $\mu$ Vrms to 8.00 Vrms [+20.28 dBu]	
Amplitude Accuracy	±0.09dB [±1.0%]	
Amplitude Resolution	0.007 dB or 0.60 $\mu$ Vrms, whichever is larger	SR/2 <sup>23</sup>
Flatness	±0.01 dB (20 Hz-20 kHz, 500 Hz ref)	±0.001 dB
THD+N <sup>1</sup> 20 Hz-20 kHz	≤(0.0009% [-101 dB] + 1.6 $\mu$ V)	0.000001% [-160 dB]
<b>Square Wave</b>		
Frequency Range	10 Hz-20 kHz	2 Hz to SR / 6, in even integer sub-multiples of SR
Risetime	Typically 2.0 $\mu$ s	N/A
<b>IMD Test Signal (SMPTE/DIN)</b>		
LF Tone Range	40 Hz to 500 Hz	40 Hz to 500 Hz
HF Tone Range	2 kHz to 60 kHz	2 kHz to 0.47 x SR
Mix Ratio	4:1 or 1:1(LF:HF)	4:1 or 1:1(LF:HF)
Residual IMD <sup>2</sup>	≤0.0025% [-92 dB]	
<b>Arbitrary Waveform (Multitone)</b>		
Length	256 to 16384 points per channel	256 to 16384 points per channel
Frequency Range	DC to 0.47 x SR	DC to 0.47 x SR
Frequency Resolution	SR / Length	SR / Length
<b>Noise Signals</b>		
Burst	Shaped burst: Raised cosine	Shaped burst: Rectangular envelope, raised cosine
<b>Analog Output Characteristics</b>		
Source Configuration	Balanced (XLR), Unbalanced (XLR and BNC), or Common Mode Test (XLR)	
Source Impedances (Rs) Balanced or Common Mode Test Unbalanced	Nominally 40 $\Omega$ or 150 $\Omega$ (200 $\Omega$ with option EURZ) Nominally 20 $\Omega$ or 50 $\Omega$	
Output Current Limit	Typically 50 mA	
Max Output Power into 600 $\Omega$		
Balanced	+24.1 dBm (Rs = 40 $\Omega$ )	
Unbalanced	+18.4 dBm (Rs = 20 $\Omega$ )	
Output Related Crosstalk (20Hz- 20kHz)	≤(-100 dB + 3 $\mu$ V)	
<b>Digital Output Characteristics</b>		
Formats Balanced (XLR) Unbalanced (BNC) Optical (Toslink®)		AES3 per AES3-1997 SPDIF-EIAJ per IEC 60958 Per IEC 60958-3
Sample Rate Range		28.8 kHz to 108 kHz per connector
Word Width		8 to 24 bits
Output Amplitude Balanced into 110 $\Omega$ Unbalanced into 75 $\Omega$ Optical (Toslink®)		Range 0 to 5.10 Vpp Range 0 to 1.275 Vpp Nominal intensity, not variable

## ANALYZER

### Audio Analyzer

Input Characteristics	Analog	Digital
Resolution w/Performance Option	24-bit sigma-delta 16-bit sigma-delta	8-24 bits
Sample Rate	28.8ks/s to 108ks/s variable; or 65.536ks/s fixed	28.8kHz to 100kHz AES/EBU; 64kHz-200kHz Dual Connector AES/EBU
w/Performance Option	56ks/s to 215ks/s variable; or 131.072ks/s or 262.144 ks/s fixed	
Input Ranges	355 mVp to 200 Vp in 6.02 dB steps	
Maximum Rated Input	200Vp, 140Vrms (dc to 20kHz); overload protected in all ranges	
Input Impedance Balanced Unbalanced	Nominally 200 k $\Omega$ Nominally 100 k $\Omega$	
CMRR <sup>3</sup> 355mVp to 5.6Vp range 11.2 Vp to 200Vp range	≥80 dB, 10 Hz-20 kHz ≥50 dB, 10 Hz-1 kHz	
Input Related Crosstalk	≤(-100 dB +3 $\mu$ V), at 20 kHz	
Formats Balanced (XLR)  Unbalanced (BNC) Optical (Toslink®)		AES/EBU (per AES 3-1997); SPDIF-EIAJ; Optical SPDIF-EIAJ per IEC 60958 Per IEC 60958-3
Sample Rates		28.8 kHz to 108 kHz per connector
Word Width		8 to 24 bits
<b>Level and Amplitude Measurement</b>	<b>Analog</b>	<b>Digital</b>
Measurement Range	<1 $\mu$ V-140 Vrms [-118 dBu to +45.1 dBu]	-120 dBFS to 0 dBFS (usable to -140 dBFS)
Accuracy (1 kHz)	±0.09 dB [±1.0%]	±0.002 dB [±0.023%]
Flatness <sup>4</sup> "HiRes" A/D "HiBW" A/D	±0.01 dB, 20 Hz to 20 kHz ±0.01dB, 20 Hz to 20 kHz; ±0.1 dB, 20k to 120 kHz	±0.002 dB, 10 Hz to 0.45xSR
Detection	RMS, FAST RMS, or QPK per IEC 468 (CCIR)	SAME
<b>Frequency Measurement Range</b>	<b>Analog</b>	<b>Digital</b>
Range With Performance Option	> 10 Hz to 30 kHz (SR = 65.536 kS/s) > 10 Hz to 120 kHz	< 10 Hz to 0.47xSR
Accuracy	±0.0002% [2 PPM]	SAME
Resolution	0.00001% of SR [0.007 Hz at 65.536 kS/s]	SAME
<b>Phase Measurement</b>	<b>Analog</b>	<b>Digital</b>
Measurement Ranges	180, -90 to +270, or 0 to +360 deg	
Accuracy		2 deg, 10 Hz to 0.45xSR
10 Hz to 5 kHz	2 deg	
5 kHz to 20 kHz	3 deg	
20 kHz to 50 kHz (With Performance Option)	4 deg	
Resolution	0.01 deg	SAME
<b>Residual Noise (Amplitude Function only)</b>	<b>Analog</b>	<b>Digital</b>
A-weighted	≤ 1.2 $\mu$ V rms	≤ -142 dBFS
Dolby 2K	≤ 2.0 $\mu$ V rms	≤ -134 dBFS
IEC 468 (CCIR)	≤ 5.0 $\mu$ V rms	≤ -127 dBFS
20 kHz LP	≤ 1.6 $\mu$ V rms	≤ -140 dBFS
<b>THD+N Function</b>	<b>Analog</b>	<b>Digital</b>
Fundamental Range	10 Hz to 0.47xSR	SAME
Measurement Range	0 to 100%	SAME
Accuracy	±0.3 dB, 10 Hz to 0.45xSR (no filters selected)	SAME
Residual THD+N	≤ 0.0009% [-101 dB] + 1.6 $\mu$ V (with 20 kHz LP)	

1-System specification including contributions from both generator and analyzer, 20 kHz measurement bandwidth.

2-System specification with 60 Hz/7 kHz or 250 Hz/8 kHz test signal combinations and Vin ≥ 200 mV.

3-CMRR performance below 50 Hz degrades with AC coupling.

4-1 kHz ref. Flatness derates above 5 kHz by an additional ±0.02 dB in the 22.4 V, 45 V, 90 V, and 200 V input ranges.

5-Requires High Performance Option.

## Amplitude & THD+N Filters

One filter from each of the following three groups may be enabled (3 filters total)

Low Pass Group	<b>F<sub>s</sub>/2</b> (no BW limiting) <b>20 kHz</b> (6-pole elliptic, 0.1 dB ripple, 110 dB stopband) <b>15 kHz</b> (6-pole elliptic, 0.1 dB ripple, 110 dB stopband) <b>User Defined</b> (6-pole maximum)
High Pass Group	<b>&lt; 10 Hz</b> (4-pole) <b>22 Hz</b> (4-pole Butterworth) <b>100 Hz</b> (4-pole Butterworth) <b>400 Hz</b> (4-pole Butterworth, or 10-pole elliptic if no other filters are enabled) <b>User Defined</b> (4-pole maximum)
Weighting Filter Group	<b>None</b> <b>ANSI-IEC "A" weighted</b> , per IEC 179 <b>IEC 468</b> (CCIR) Qpk <b>Dolby 2K</b> (CCIR-ARM) <b>C-message</b> per IEEE 743-1978 <b>CCITT</b> per Rec 0.41 <b>"F" weighted</b> per 15 phon loudness contour <b>HI-2 Harmonic weighting</b> <b>User Defined</b> (8-pole maximum)

Bandpass & Crosstalk Functions	Analog	Digital
Tuning Range	20 Hz to 0.47xSR	SAME
Bandpass Response	10-pole, Q=19	SAME
Accuracy (at center frequency)	±0.2 dB	±0.2 dB
Residual Noise		≤-150 dBFS
10 Hz to 5 kHz	≤0.5 μV [-124 dBu]	
5 kHz to 20 kHz	≤1.0 μV [-118 dBu]	

SMPTE (DIN) IMD Function	Analog	Digital
Test Signal Compatibility	Any combination of 40 Hz to 250 Hz (LF) and 2 kHz to 0.45xSR (HF), mixed in any ratio from 1:1 to 5:1 (LF:HF)	SAME
IMD Measured	Amplitude modulation products of the HF tone. Measurement bandwidth is typically 20 Hz to 750 Hz	SAME
Measurement Range	0 to 20%	
Accuracy	±0.5 dB	
Residual IMD <sup>6</sup>	≤0.0025% [-92 dB]	≤0.00003% [-130 dB] at 0 dBFS ≤0.0003% [-110 dB] at -25 dBFS

FFT Analyzer	Analog	Digital
Acquisition Length	800 to 256 k samples in 11 steps	SAME
Transform Length	256 to 32768 samples in binary steps	SAME
Windows	None None-move-to-bin-center Hann Hamming Blackman-Harris (4-term, -92 dB sidelobes) Equiripple (AP design with -160 dB sidelobes) Flat-top Gaussian Rife-Vincent 4-term Rife-Vincent 5-term	
Amplitude Accuracy (Flat-top window)	±0.10 dB [±1.2%]	±0.001 dB [±0.012%]
Phase Accuracy <sup>7</sup>	±0.5 deg, 10 Hz to 5 kHz ±1 deg, 5 kHz to 20 kHz ±2 deg, 20 kHz to 50 kHz (with Performance Option)	±0.05 deg, 10 Hz to 0.45xSR

Averaging	1 to 4096 in binary steps Power-based (frequency domain) Synchronous (time domain)	SAME
Residual Distortion	≤-105 dB, SR=65 kS/s ≤-90 dB, SR=262 kS/s (with Performance Option)	≤-180 dB
Analog Alias Rejection Standard ("HiRes" A/D) Performance Option ("HiBW" A/D)	Typically >115 dB for signals >0.554xSR Typically > 85 dB for signals >0.540xSR	

Multitone Analyzer	Analog	Digital
Acquisition and Transform Lengths	512 to 32768 samples in binary steps	SAME
Frequency Resolution	SR / Length [2.0 Hz with SR = 65.536 kS/s and Length = 32,768]	SAME
Residual Distortion	≤-105 dB, SR = 65 kS/s ≤-90 dB, SR = 262 kS/s (with Performance Option)	-140 dBFS

Harmonic Distortion Analyzer	Analog	Digital
Harmonic Sum Range	Any combination of 2 <sup>nd</sup> through 15 <sup>th</sup> within the range of 20 Hz to 0.498*SR	
Amplitude Accuracy	±(0.10 dB + 0.3 μV)	±0.001 dB, 0 to -80 dBFS; ±0.01 dB, -80 to -120 dBFS; ±0.10, -100 to -120 dBFS
Residual Distortion		-150 dB
"HiRes" A/D	≤-105 dB, SR ≤ 65KS	
"HiBW" A/D <sup>8</sup>	≤-90 dB	

SYNC/Reference Input	
Signal Compatibility	AES3 Video Squarewave

Auxiliary Signals	
	Monitor Outputs Trigger Input Trigger Output

Digital Interface	Analyzer	Generator
Input Sample Rate	±0.0003% [±3 PPM] internal ref ±0.0001% [±1 PPM] external ref	

Input Voltage		
Balanced (XLR)	200 mV to 5.10 Vpp, ±(10% + 50 mV)	
Unbalanced (BNC)	100 mV to 1.275 Vpp, ±(10% + 12 mV)	
Jitter Amplitude (peak calibrated)		0.05 to 0.1275 UI in 0.0005 UI steps 0.130 to 1.275 UI in 0.005 UI steps 1.30 to 12.75 UI in 0.05 UI steps
50 – 100 kHz BW other BW selections	0 to 3.00 UI, ±(10% + 2 ns) 0 to 1.00 UI, ±(10% + 2 ns)	
Jitter Frequency Range		20 Hz to 200 kHz, 0.1 Hz resolution ±(10% + 2ns)

Jitter Accuracy (500 Hz)		
Jitter Flatness <sup>8</sup>	±1 dB, 100 Hz to 20 kHz	±1 dB, 100 Hz to 20 kHz
Residual Jitter <sup>9</sup>	≤ 2 ns [0.012 UI at 48 kS/s, 0.024 UI at 96 kS/s]	≤ 2.0 ns [0.012 UI at 48 kS/s, 0.024 UI at 96 kS/s]
Jitter Spectrum	Spurious products are typically .003 UI [-50 dBUI] or 30 dB below jitter signal, whichever is larger	Spurious products are typically .003 UI [-50 dBUI] or 30 dB below jitter signal, whichever is larger

Channel Status Bits	Full implementation per IEC 60958, English language decoded, common to both channels	Full implementation per IEC 60958, English language decoded, common to both channels
Formats	Professional or consumer, or Direct Hex source	
Validity Flag	Displayed for each channel	Selectable-set or cleared, common to both channels
Parity; Signal Confidence; Receiver Lock; Coding Error	Displayed for total signal (both channels combined)	

## AUXILIARY SIGNALS

Two Analyzer Input Monitors; Two Analyzer Reading Monitors; Trigger Output that can be selected from one of several sources including Generator Analog Sync, Digital Sync Output, and several others

## AUDIO MONITOR

Internal speaker and phone jack for external speaker or headphone. Software volume control. Power Output, typically 1 Watt.

## GENERAL / ENVIRONMENTAL

Power Requirements	100/120/230/240 Vac (-10% +6%), 50-60 Hz, 75 VA max
Temperature Range	5°C to +45°C Operating; -40°C to +75°C Storage
Humidity	90% RH to at least +40°C (non-condensing)
EMC <sup>10</sup>	Complies with 89/336/EEC, CISPR 22 (class B), and FCC 15 subpart J (class B)
Dimensions	18.8 x 3.0 x 14.2 inches [42.7 x 7.6 x 36.1 cm]
Weight	Approximately 14.8 lbs [6.7 kg] unpacked
Safety	Complies with 73/23/EEC, 93/68/EEC, and EN61010-1 (1990) + Amendment 1 (1992) + Amendment 2 (1995). Installation Category II, Pollution Degree 2

6-System specification with 60 Hz/7 kHz or 250 Hz/8 kHz test signal combinations and Vin ≥ 200 mV.

7-Both analyzer input channels must have same coupling (AC or DC) selection. Analog accuracy is valid for any input signal amplitude ratio up to ±30 dB.

8-System specification including contributions from both analyzer and generator. Valid at 32.0, 44.1, 48.0, 65.536, 88.2, and 96.0 kS/s only. Flatness may degrade at other sample rates.

9-System specification valid only if (1) the jitter generator amplitude is turned off; (2) the digital input is ≥ 1.0 Vpp (XLR) or ≥ 250 mVpp (BNC); and (3) the analyzer is set for 700 Hz-100 kHz bandwidth.

10-Emission and immunity levels are influenced by the shielding performance of the connecting cables. EMC compliance was demonstrated using Audio Precision part numbers CAB-XMF and CAB-AES2.

## Configuration and Ordering Guide:

The standard ATS-2 comes with all control software and interface hardware to connect to your PC. The optional Performance Option can be added to provide a high bandwidth analysis capability and serial digital interface measurements. The Audio Analyzer, Harmonic Analyzer, FFT Analyzer, and Multitone Analyzer bandwidths are increased from 30 kHz to 120 kHz. The Digital Interface Analyzer adds: Jitter Spectrum analysis, Jitter Waveform, Interface Spectrum analysis, Interface Waveform (Oscilloscope), Eye pattern, Interface amplitude histogram, Interface Rate histogram, and Interface bit-width histogram. All other features and capabilities are identical.

ATS-2 connects to your PC with one of two possible interfaces. The standard interface uses a PCI card. As an option, this can be changed to a PCMCIA card.

### Options & Ordering Information

**ATS-2** PC-controlled Audio Test System with APiB interface

#### Interface Control Packages (select one at time of order)

ATS2-PCI	PCI interface card for ATS-2 (not for Win 95)
ATS2-PCMCIA	PCMCIA interface card for ATS-2

#### Options for ATS-2

ATS2-PERF	Performance Option for ATS-2
ATS2-RAK	Rack mount kit for ATS-2
ATS2-CAS	Protective soft carrying case for ATS-2 (see picture below)
EWP-ATS2	Three-Year Extended Warranty (Adds three more years to standard three-year warranty included with instrument)
MAN-ATS2	Additional ATS-2 Getting Started Manual and ATS-2 User's Manual (one of each is included with instrument)

#### Additional Interface Control Packages (to control instrument from more than one computer)

PCI-WIN-KITATS2	PCI ATS interface kit for ATS-2. Includes PCI ATS interface card, cable, ATS software, User Manual, and Getting Started Manual
PCM-WIN-KITSATS2	PCMCIA ATS interface kit for ATS-2. Includes PCMCIA ATS interface card, cable, ATS software, User Manual, and Getting Started Manual



*Soft carrying case option. Padded interior protects your ATS-2, and has an extra pocket for your notebook computer, documentation, and cables.*

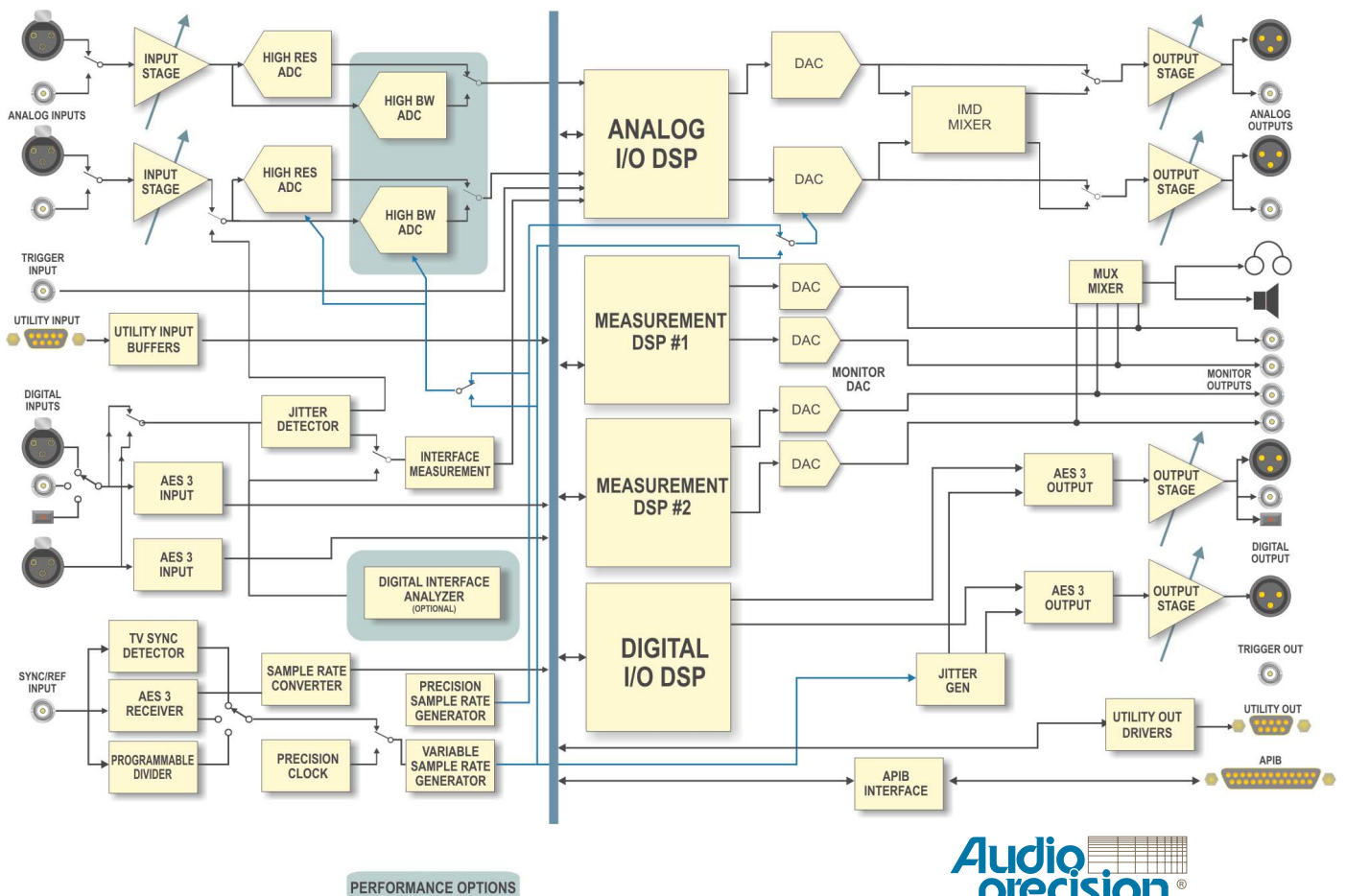

**Audio precision**

Testing for Optimal Results

5750 SW Arctic Drive  
Beaverton, Oregon 97005  
Tel 503-627-0832 Fax 503-641-8906  
US Toll Free 1-800-231-7350  
email: sales@audioprecision.com  
web: audioprecision.com